

WATERSTOP-RX[®] PRODUCT MANUAL

EXPANDING CONCRETE JOINT WATERSTOP



WATERSTOP-RX®

EXPANDING CONCRETE JOINT WATERSTOP

CONTENTS

Section 1: Product Description

Section 2: General Applications

Section 3: General Installation Procedures

Section 4: Penetrations

Section 5: Pile Caps and Grade Beams

Section 6: Property Line Installations

Section 7: Irregular Concrete Surfaces

Section 8: Joining Waterstop-RX to PVC Waterstops

SECTION 1 PRODUCT DESCRIPTION

Waterstop-RX is a flexible strip concrete construction joint waterstop that provides a permanent seal by expanding upon contact with water. Waterstop-RX is an active sodium bentonite based waterstop that is designed to replace conventional passive PVC dumbbell waterstops, thus eliminating the requirement of split-forming and product seam welding.

Waterstop-RX is manufactured in light weight, flexible coils that can be installed in both hot and cold weather. The product is adhered to concrete, steel, and PVC (pipes) with CETSEAL; at or exceeding the required minimum distance from the exterior concrete surface.

The key to Waterstop-RX is sodium bentonite. Sodium bentonite swells when in contact with water, forming an impermeable barrier. This swelling property allows Waterstop-RX to form a permanent pressure seal within the concrete joint, thus eliminating water migration over or along the waterstop (see Figure 1.1). In addition to forming a positive pressure seal, the product's expansion properties allow it to seal small cracks and void areas. Waterstop-RX has been successfully tested by independent testing firms to over 200 feet (60 meters) of hydrostatic water pressure, under both continuous emersion and wet/dry cycling.

Waterstop-RX is extruded in three sizes and shapes (see Figure 1.2). Waterstop-RX 101 is extruded in a rectangular shape measuring 1"x3/4"x16'8" (25mm x 19mm x 5.03m). Waterstop-RX 101T is extruded in a trapezoidal shape measuring 1-1/4" x 1/2" x 20' (31mm x 12mm x 6m) with a reinforcing plastic scrim embedded in the top surface for high tensile strength. The patented trapezoidal shape distributes the expansive force over a greater area. Waterstop-RX 102 is

extruded in half-circle (crescent) shape measuring 3/4" x 3/8" x33' 4" (19mm x 9mm x 10m). See Table 1.

CETSEAL is a multi-purpose, single component polyether moisture cure adhesive used to secure Waterstop-RX into position. Apply a continuous bead of CETSEAL to substrate then install Waterstop-RX before CETSEAL skins over and cures. Adhesive yeild will vary with use, substrate and application.

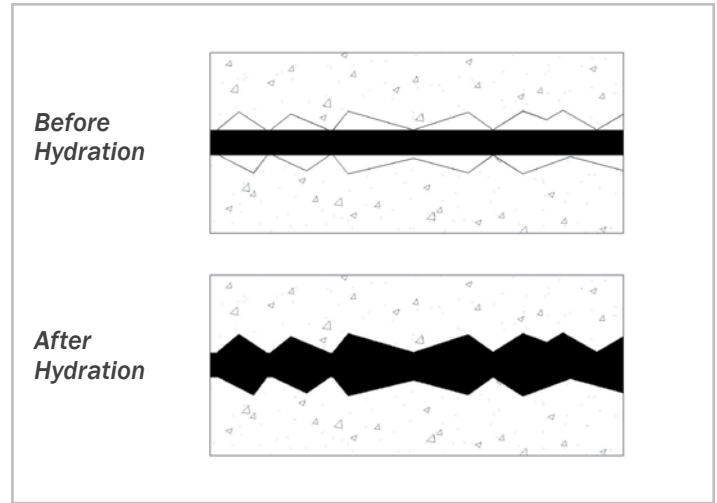

Figure 1.1 - Swelling property of Waterstop-RX

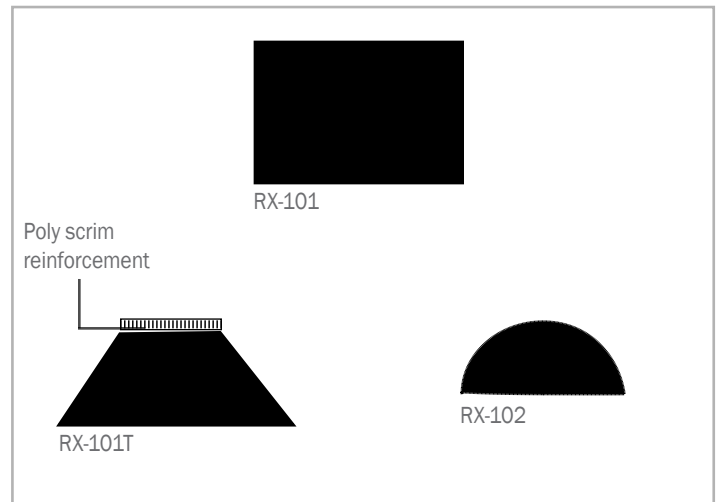

Figure 1.2 - Three sizes and shapes of Waterstop-RX

SECTION 2 GENERAL APPLICATIONS

Waterstop-RX applications include both vertical and horizontal concrete construction joints, new-to-existing construction, irregular surfaces, and around throughwall penetrations, such as plumbing and electrical conduit. Waterstop-RX is designed for both hydrostatic and non-hydrostatic conditions. Waterstop-RX is not designed, nor intended to function as an expansion joint sealant. Contact manufacturer for pre-cast concrete applications, technical information and approval.

Waterstop-RX is designed for structural concrete with a minimum of 3000 psi. 101 and 101T, require a minimum 3" (75mm) of concrete coverage. Waterstop-RX 102 requires a minimum concrete coverage of 2" (50mm).

RX 101 and RX 101T are designed for vertical and horizontal reinforced concrete 8" (200mm) thick or greater, with two rows of reinforcing steel (see Figure 2.1). RX 101T (trapezoidal) is recommended for shotcrete or gunite concrete construction, extreme hot weather and difficult applications. RX 102 is designed for vertical reinforced concrete 5" (125mm) thick or greater; and horizontal reinforced concrete 4" (100mm) thick or greater. RX 102 is designed primarily for concrete with one row of reinforcement, concrete curbs, planter walls, and light weight concrete.

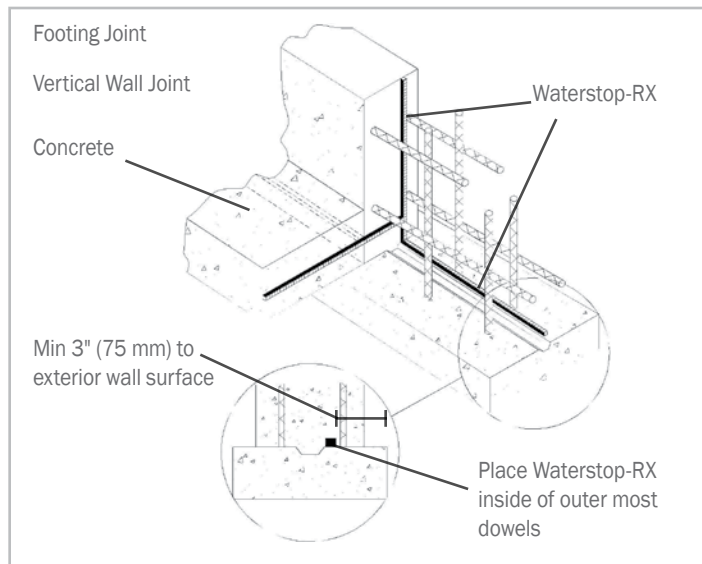

Figure 2.1 - Typical placement of Waterstop-RX at concrete construction joint

SECTION 3 GENERAL INSTALLATION

SURFACE PREPARATION

Surfaces should be clean and dry. Remove all dirt, rocks, rust or other debris. Do not install Waterstop-RX in standing water.

ADHESIVE

Apply a continuous bead of CETSEAL along the substrate where Waterstop-RX will be installed. Assure proper 3" (75 mm) concrete coverage will be maintained. Keep the nozzle tip pressed against the concrete at a 45° angle during application.

INSTALLATION

After applying a continuous bead of CETSEAL, remove release paper, then firmly press the entire length of Waterstop-RX onto the adhesive. For vertical and overhead applications, firmly press a minimum of 15 seconds to assure adhesion. Apply Waterstop-RX within 30 minutes of adhesive installation; waterstop must be placed into adhesive prior to CETSEAL skinning over and curing. CETSEAL may be applied to damp surfaces, but not in standing water.

Waterstop-RX is not a self-adhering product. Use CETSEAL to adhere the product. Mechanical fasteners should not be used to secure product alone, but may be used in conjunction with CETSEAL.

Tightly butt coil ends together to form a continuous waterstop (do not overlap coil ends). Place in maximum practical lengths to minimize coil end joints. Where required, cut coils with knife or utility blade to fit coil ends together. Pour Concrete.

LIMITATIONS

Waterstop-RX is not designed, nor intended to function as an expansion joint sealant. RX-101 and RX 101T require a 3" (75mm) minimum concrete coverage to the exterior concrete surface (see Figure 3.1). RX 102 requires a 2" (50mm) minimum concrete coverage to the exterior concrete surface (see Figure 3.2).

Concrete work shall use conventional cast-in-place forms that produce a smooth surface. Do not use stay-in-place concrete forming; use removable forming products only.

For concrete or other construction techniques not covered herein, contact CETCO regarding product use and installation guidelines.

PRODUCT TABLE

PRODUCT	SIZE	SHAPE	LN FT/CARTON	MIN CONCRETE COVERAGE
RX-101	1" X 3/4" X 16'8"	Rectangle	100	3" (75 mm)
RX-101T	1 1/4" x 1/2" x 20'	Trapezoid with poly reinforcement	120	3" (75 mm)
RX-102	3/4" x 3/8" x 33' 4"	Half circle	200	2" (50 mm)

CETCO[®]

www.CETCO.com

WATERSTOP-RX®

EXPANDING CONCRETE JOINT WATERSTOP

Waterstop-RX should not be prehydrated by submersion or remain in contact with water prior to concrete pour. If the product exhibits considerable swell prior to confinement in the joint, it must be replaced with new material.

In conditions where severe ground water chemical contamination exists, or is expected, consult with manufacturer for compatibility information and approval.

Waterstop-RX is recommended for installation outside of any formed keyway in poured-in-place concrete construction. Waterstop-RX can be installed in a formed keyway with the approval of the structural engineer. Consult manufacturer for recommendations on conditions not represented herein.

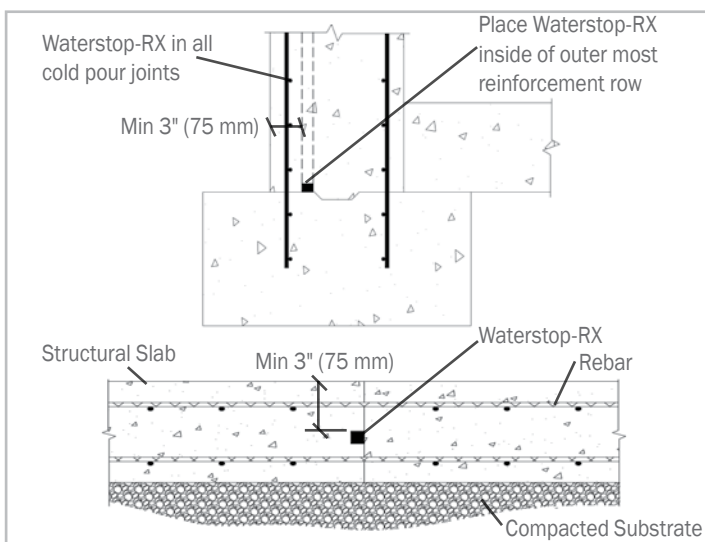

Figure 3.1 - Placement of Waterstop-RX 101 & 101T at typical construction joints with required 3" (75 mm) concrete coverage.

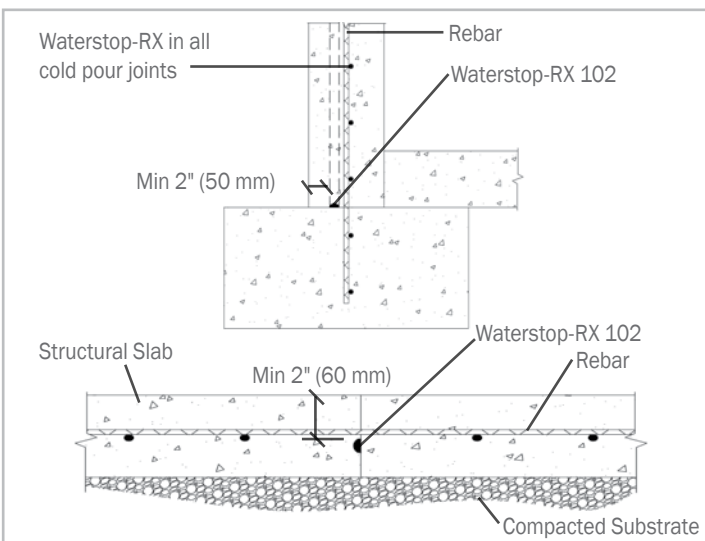

Figure 3.2 - Placement of Waterstop-RX 102 at typical construction joints with required 2" (50 mm) concrete coverage.

SECTION 4 PENETRATIONS

Following the General Installation Procedures in Section 3, install Waterstop-RX® directly around all applicable single and multiple poured-in-place or sleeved pipe penetrations (see Figure 4.1).

Single Pipe Penetration: Install Waterstop-RX around outer diameter of the pipe (see Figure 4.2). Waterstop-RX 102 shall be installed around all polyvinyl chloride (PVC) pipes.

Multiple Pipe Penetrations: Install Waterstop-RX around each pipe, as well as, around any block out box construction joint. Waterstop-RX 102 shall be installed around penetrations with less than 4" (100mm) between penetrations (see Figure 4.3).

Sleeved Pipe Penetrations: Install Waterstop-RX around the outer diameter of the sleeve. Install another Waterstop-RX strip between the sleeve's inner diameter and the pipe, contacting both surfaces continuously (see Figure 4.4). When there is an excessive gap between the inner diameter of the sleeve and the pipe, it may be necessary to install two separate Waterstop-RX strips - one on the inner diameter and the other on the pipe. Then completely fill the void area between the sleeve and the pipe with non-shrink grout (see Figure 4.5).

Consult manufacturer for recommendations on conditions not represented herein.

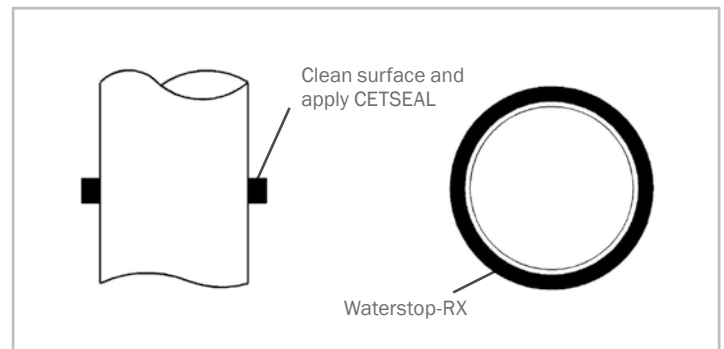

Figure 4.1 - Waterstop-RX installed around all applicable penetrations.

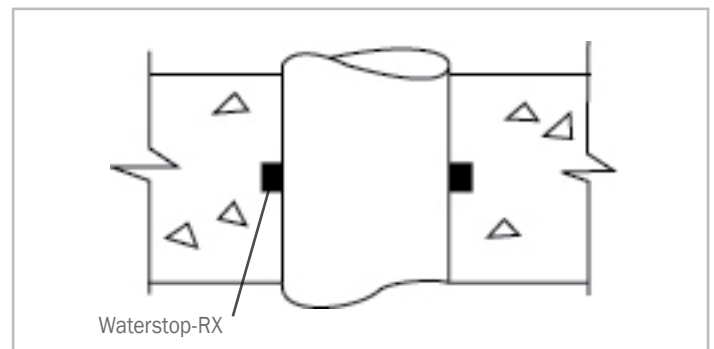

Figure 4.2 - Single pipe penetration

SECTION 5 PILE CAPS AND GRADE BEAMS

Following the General Installation Procedures in Section 3, install Waterstop-RX in all applicable concrete construction joints around or adjacent to pile caps and grade beams.

Install Waterstop-RX around pile caps and grade beams above the layer (not contacting) of exterior waterproofing to establish a separate waterstop layer (see Figure 5.3). Contour all I-beams extending outward from pile caps with Waterstop-RX (see Figure 5.1) or encircle all metal reinforcement rods extending out of pile caps (see Figure 5.2).

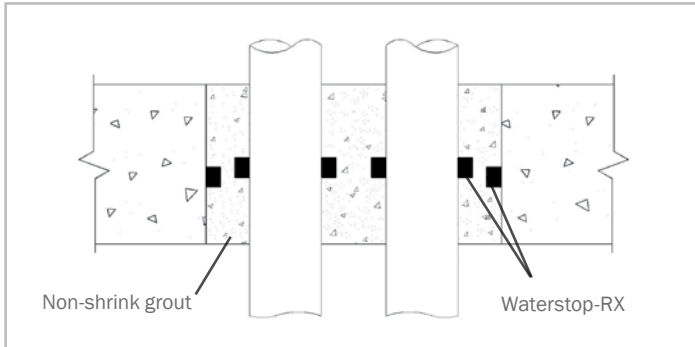

Figure 4.3 - Multiple pipe penetration

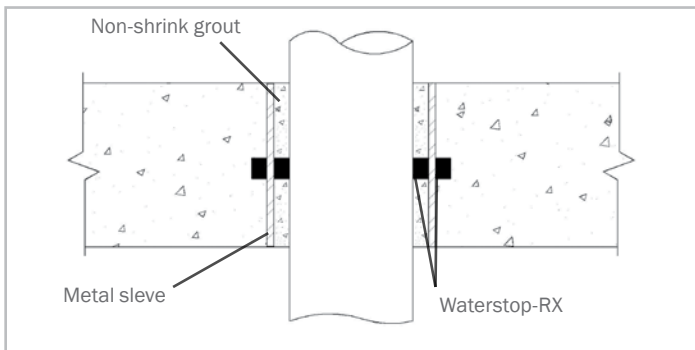

Figure 4.4 - Sleeved Pipe

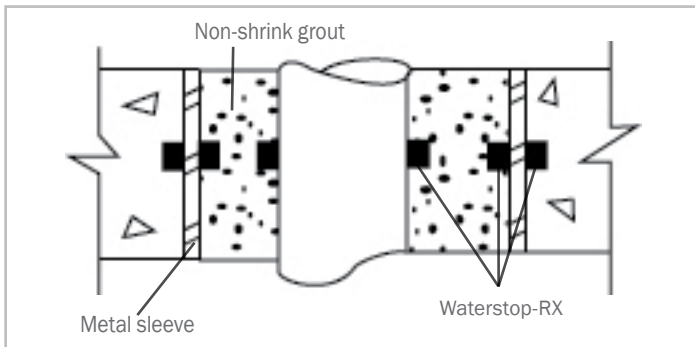

Figure 4.5 - Sleeved pipe (excessive gap)

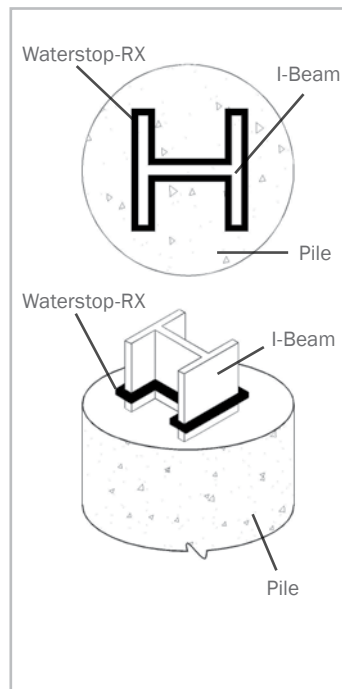

Figure 5.1 - Waterstop-RX encircling pile cap metal I-beam

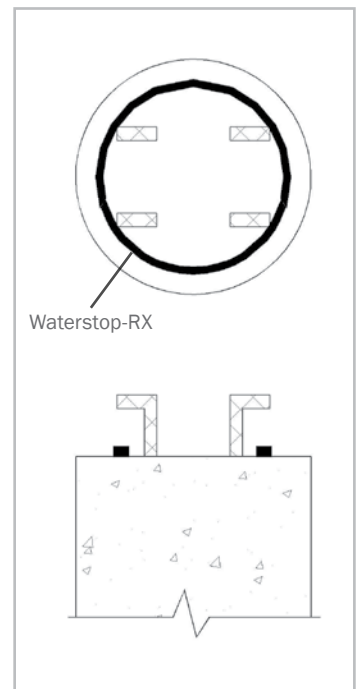

Figure 5.2 - Waterstop-RX encircling pile caps metal reinforcement

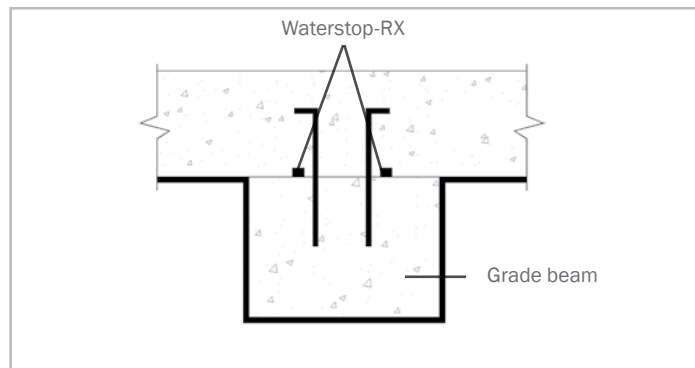
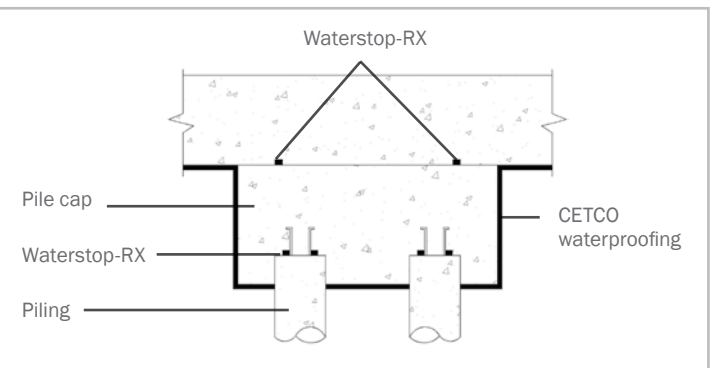

Figure 5.3 - Waterstop-RX at grade beams and pile caps



WATERSTOP-RX®

EXPANDING CONCRETE JOINT WATERSTOP

SECTION 6 PROPERTY LINE INSTALLATIONS

Following the General Installation Procedures in Section 3, install Waterstop-RX® in all applicable horizontal and vertical construction joints within the structural property line wall, including concrete interface joints with soldier piles.

Install Waterstop-RX directly to soldier piles when wood lagging is positioned outside the piles toward the retained earth or when the wood lagging is positioned adjacent to the pile's outer flange (see Figure 6.1).

Install Waterstop-RX within all applicable concrete construction joints when the wood lagging is positioned adjacent to the soldier piles inside flange (see Figure 6.2).

Install Waterstop-RX in all applicable concrete construction joints for metal sheet piling or concrete cassion construction. Install Waterstop-RX around all soldier pile tie-back boxes through wall construction joints (see Figure 6.3).

Use Waterstop-RX 101T (trapezoidal) for shotcrete or gunite concrete construction. With shotcrete wall construction, a single strip of Waterstop-RX shall be installed in all shotcrete lift joints. For hydrostatic conditions, two strips of Waterstop-RX shall be installed in all shotcrete cold construction joints.

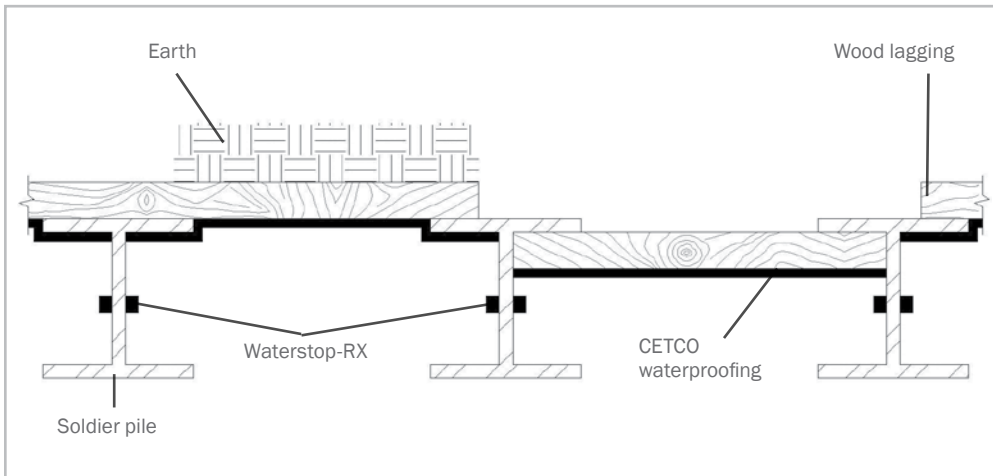

Figure 6.1 - Waterstop-RX installed when wood lagging is positioned outside the soldier piles or adjacent to piles outer flange

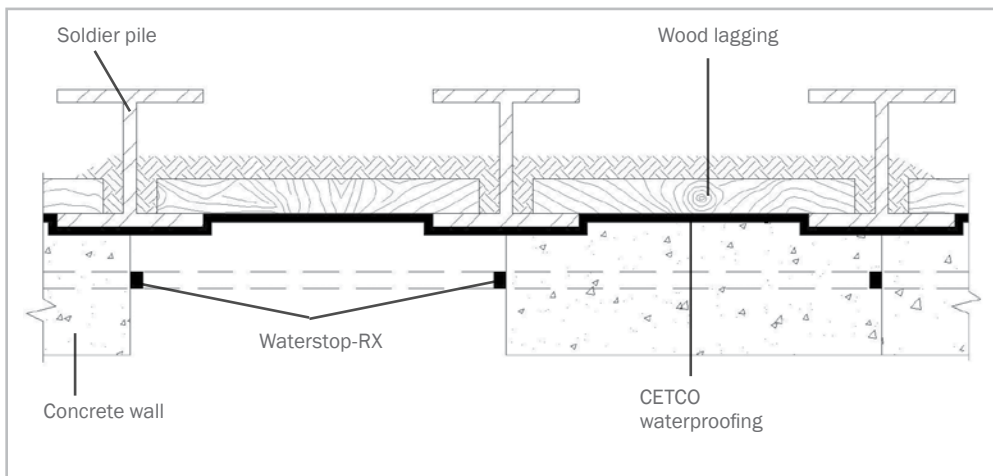

Figure 6.2 - Waterstop-RX installed when wood lagging is positioned adjacent to soldier piles inside flange

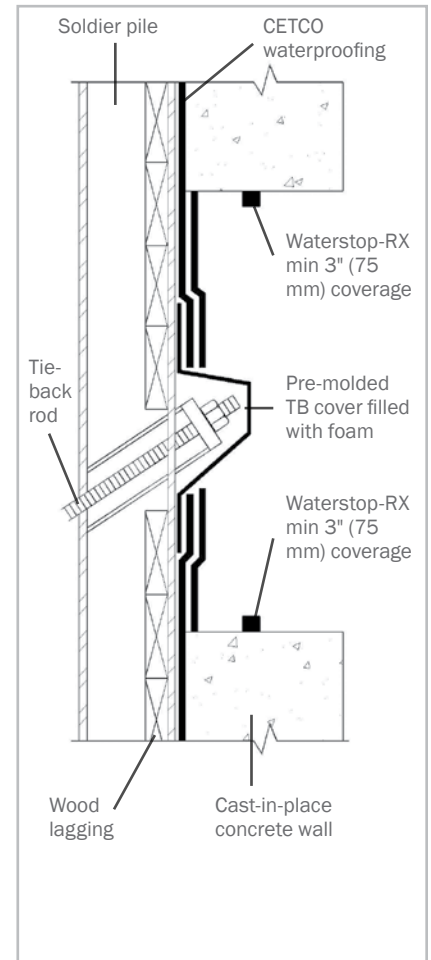

Figure 6.3 - Typical tie-back section detail prior to grouting

SECTION 7 IRREGULAR CONCRETE & STONE SURFACES

Following the General Installation Procedures in Section 3, install Waterstop-RX® to existing irregular concrete or stone surfaces.

Press Waterstop-RX continuously against irregular surface, contouring all rises and depressions (see Figure 7.1). Do not span cavities or cracks leaving a gap between the surface and the Waterstop-RX. In special conditions it may be necessary to install Waterstop-RX in an irregular path to circumvent deep depressions or cracks.

SECTION 8 JOINING WATERSTOP-RX TO PVC WATERSTOPS

Following the General Installation Procedures in Section 3, install Waterstop-RX on the exterior side of the PVC dumbbell waterstop (see Figure 8.1). Waterstop-RX should be in direct contact and overlap the passive PVC dumbbell waterstop by a minimum of 3" (75mm).

Consult manufacturer for recommendations on conditions not represented herein.

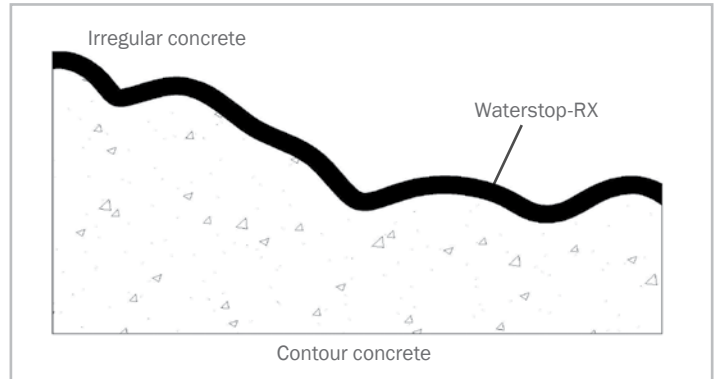

Figure 7.1 - Waterstop-RX installed on irregular concrete

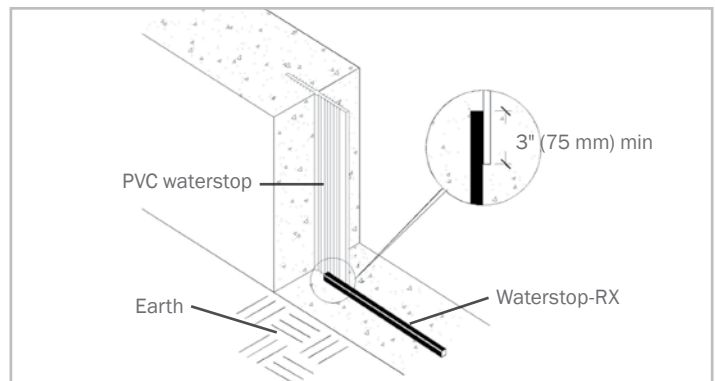

Figure 8.1 - Overlapping dumbbell waterstop

LIMITED WARRANTY

The information and data contained herein is believed to be accurate and reliable. Specifications and other information contained herein supersede all previously printed material and are subject to change without notice.

Manufacturer's warranty of installed system is available. Contact seller for terms and sample documents including all limitations.

All goods sold by seller are warranted to be free from defects in material and workmanship.

The foregoing warranty is in lieu of and excludes all other warranties not expressly set forth herein, whether expressed or implied by operation of law or otherwise including but not limited to any implied warranties of merchantability or fitness.

Seller shall not be liable for incidental or consequential losses, damages or expenses, directly or indirectly arising from the sale, handling or use of the goods, or from any other cause relating thereto, and seller's liability hereunder in any case is expressly limited to the replacement (in the form originally

shipped) of goods not complying with this agreement or at seller's election, to the repayment of, or crediting buyer with, an amount equal to the purchase price of such goods, whether such claims are for breach of warranty or negligence.

Any claim by buyer with reference to the goods sold hereunder for any cause shall be deemed waived by buyer unless submitted to seller in writing within thirty (30) days from the date buyer discovered or should of discovered, any claimed breach.

Materials should be inspected and tested by purchaser prior to their use if product quality is subject to verification after shipment. Performance guarantees are normally supplied by the applicator.

Note: Waterstop-RX is not an expansion joint material. Expansion joints shall be the responsibility of Others.

CETCO®

www.CETCO.com



AMCOL® INTERNATIONAL HEADQUARTERS



Headquartered in Hoffman Estates, IL, AMCOL operates over 68 facilities in Africa, Asia, Australia, Europe, North America and South America. The company employs approximately 1,750+ employees in 26 countries. The Company, established in 1927, currently trades on the New York Stock Exchange under the symbol "ACO". AMCOL International produces and markets a wide range of specialty mineral products used for industrial, environmental and consumer-related applications. With more than 68 world-wide locations, AMCOL manages a global supply chain to deliver world-class quality. Our full range of products and services allow us to bring value to our customers, but ultimately, we believe our commitment to understanding customers' needs is what sets us apart in our industry.

AUGUST 2010

IMPORTANT: The information contained herein supersedes all previous printed versions, and is believed to be accurate and reliable. For the most up-to-date information, please visit www.CETCO.com. CETCO accepts no responsibility for the results obtained through application of this product. CETCO reserves the right to update information without notice.

© 2010 CETCO | PRINTED IN THE USA ON RECYCLED PAPER | FORM: RXPM - 08/2010

2870 Forbs Avenue, Hoffman Estates, IL 60192
847.851.1700 | 800.527.9948 | cetco.com



CETCO, a wholly owned subsidiary of AMCOL International Corp.